

# JVC



## VIDEO CD PLAYER

影音光碟机

# XL-MV777GD/XL-MV757TN

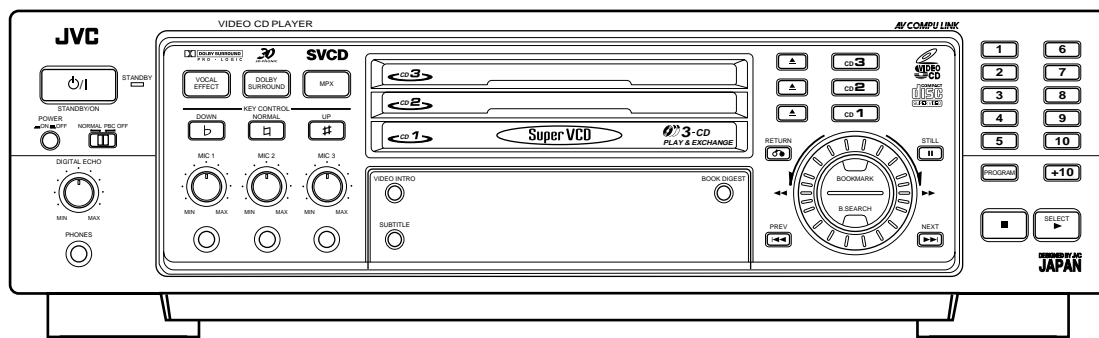
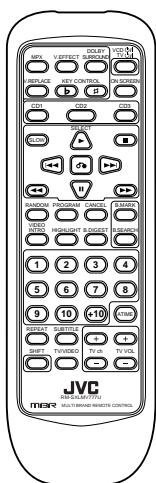

PlayBack  
Control

Super VCD



## INSTRUCTIONS

使用说明书

### For Customer Use:

Enter below the Model No. and Serial No. which are located either on the rear, bottom or side of the cabinet. Retain this information for future reference.

Model No.

Serial No.

LVT0194-001B  
[U, US]

# Warnings, Cautions and Others / Avisos, precauciones y otras notas / Advertências, precauções e outras notas / 警告，注意及其他须知事项

## تحذيرات، تنبيهات وأشياء أخرى

### CAUTION

To reduce the risk of electrical shocks, fire, etc.:

1. Do not remove screws, covers or cabinet.
2. Do not expose this appliance to rain or moisture.

### PRECAUCIÓN

Para reducir riesgos de choques eléctricos, incendio, etc.:

1. No extraiga los tornillos, los cubiertas ni la caja.
2. No exponga este aparato a la lluvia o a la humedad.

### ATENÇÃO

Para reduzir riscos de choques eléctricos, incêndio, etc.:

1. Não retire parafusos nem desmonte as tampas ou o gabinete.
2. Não exponha este aparelho à chuva nem à umidade.

### 警告

为了减低触电，火灾等危险：

1. 请勿擅自卸下螺丝钉，盖子或机壳。
2. 切勿让本机受雨淋或置潮湿环境中。



### تحذير

لتجنب خطر الحريق، الصدمات الكهربائية، الخ.:

١. لا تقم بفك البراغي، الاغطية أو الخزانة.
٢. لا تقم بتعريض هذا الجهاز للمطر أو للرطوبة.

### Caution — POWER switch and STANDBY/ON button!

This apparatus is provided with a POWER switch to be able to minimize power consumption for safe use. Therefore,

1. When doing initial setting, complete all the connections required, connect the mains plug into the wall outlet, and set the POWER switch to ON. After these, it will be available to operate STANDBY/ON  button and so on.
2. When not in use, set the POWER switch to OFF.
3. Disconnect the mains plug to shut the power off completely. The POWER switch and STANDBY/ON  button in any position do not disconnect the mains line.
4. The power can be remote controlled.



### Precaución — Interruptor POWER y botón STANDBY/ON !

Esta unidad dispone de un interruptor POWER que sirve para reducir al mínimo el consumo de alimentación para proporcionar mayor seguridad operacional. Por lo tanto,

1. Al ejecutar el ajuste inicial, después de completar todas las conexiones requeridas, conectar el cable de alimentación a una toma de pared, y activar el interruptor POWER. Entonces, será posible ejecutar operaciones tales como la conmutación del estado de alimentación.
2. Desactivar el interruptor POWER al dejar la unidad fuera de uso.
3. Desconectar el cable de alimentación para desactivar la alimentación totalmente. Cualquier que sea la posición de ajustes del interruptor POWER y el botón STANDBY/ON /I, la alimentación no es cortada completamente.
4. La alimentación puede ser controlada remotamente.



### Precaução — Interruptor POWER e botão STANDBY/ON !

Este aparelho dispõe de um interruptor POWER que possibilita reduzir ao mínimo o seu consumo de energia por medida de segurança. Assim,

1. Nos ajustes iniciais, efetue todas as conexões necessárias, ligue o plugue de alimentação à tomada e coloque o interruptor POWER em ON. Feito isso, será possível operar o botão STANDBY/ON /I e as diversas funções.
2. Quando não utilizar o aparelho, coloque o interruptor POWER em OFF.
3. Remova o plugue de alimentação da tomada para desligar o aparelho completamente. O interruptor POWER e o botão STANDBY/ON /I, em qualquer de suas posições, não desligam a alimentação do aparelho.
4. É possível controlar remotamente a função do interruptor POWER.



### 注意—POWER开关及STANDBY/ON 键！

本机备有POWER开关，能减少电能消耗，使用安全。因此：

1. 在开始设定时，确保完成所有必要的衔接，主电源插头衔接至墙壁插座。并且把POWER开关置为ON（开始）之后，它使可操作STANDBY/ON  键等等。
2. 不用本机时，把POWER开关置为OFF（开关）。
3. 若要完全切断电源，必须把主电源插头拔出。POWER开关和STANDBY/ON  键的任何位置皆不能切除主电源。
4. 遥控器可用来开关电源。

### تحذير - مفتاح الطاقة الكهربائية POWER و زر الاستعداد للتشغيل/التشغيل !

هذا الجهاز مزود بمفتاح للطاقة الكهربائية POWER ليكون بالامكان تقليل استهلاك الطاقة الكهربائية وايضا من اجل سلامة الاستعمال. لذلك يرجى عمل ما يلي.

١. عند اجراء الضبط الاولي، اعمل كافة التوصيلات المطلوبة، واصل قابس الطاقة الكهربائية مع فتحة مخرج الطاقة الكهربائية، ثم اضبط مفتاح الطاقة الكهربائية POWER على وضع التشغيل ON بعد ذلك، سيكون بالامكان تشغيل زر الاستعداد للتشغيل/التشغيل /I و هكذا.
٢. في حالة عدم استعمال الجهاز، اضبط مفتاح الطاقة الكهربائية POWER على وضع ايقاف التشغيل OFF.
٣. انزع قابس الطاقة الكهربائية من اجل فصل الطاقة الكهربائية كلياً عن الجهاز. لا يفصل مفتاح الطاقة الكهربائية POWER و زر الاستعداد للتشغيل/التشغيل /I في أي وضع خط الطاقة الكهربائية الرئيسي عن الجهاز.
٤. يمكن التحكم عن بعد بالطاقة الكهربائية.

**IMPORTANT FOR LASER PRODUCTS / IMPORTANTE PARA PRODUCTOS LÁSER / IMPOTANTE PARA PRODUTOS LASER / 雷射产品的重要说明 / مهم للمنتجات الليزرية**

**REPRODUCTION OF LABELS / REPRODUCCIÓN DE ETIQUETAS / REPRODUÇÃO DE ETIQUETAS**

标签内容说明 / انتاج اللاصقات

① CLASSIFICATION LABEL, PLACED ON REAR ENCLOSURE

① ETIQUETA DE CLASIFICACIÓN, PEGADA EN LA PARTE POSTERIOR DE LA CAJA

① ETIQUETA DE CLASSIFICAÇÃO LOCALIZADA NA PARTE POSTERIOR DA CAIXA DO APARELHO.

① 分类标签，贴在机壳背后。

① لاصق التصنيف، موضوعة على المرفق الخلفي

② WARNING LABEL, PLACED INSIDE THE UNIT

② ETIQUETA DE ADVERTENCIA, PEGADA EN EL INTERIOR DE LA UNIDAD

② ETIQUETA DE ADVERTÊNCIA LOCALIZADA NA PARTE INTERNA DA UNIDADE.

② 警告标签，贴于机内。

② لاصقة التحذير، موضوعة بداخل الجهاز

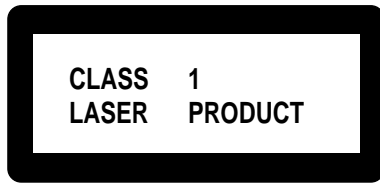

**DANGER:** Invisible laser radiation when open and interlock failed or defeated. AVOID DIRECT EXPOSURE TO BEAM. (e)

**WARNING:** Osynlig laserstrålning när denna del är öppnad och spärren är urkopplad. Betrakta ej strålen. (s)

**ADVARSEL:** Usynlig laserstrålning ved åbning, når sikkerhedsafbrydere er ude af funktion. Undgå udsættelse for strålning (d)

**VARO:** Avattaessa ja suojalukitus ohitettaessa olet alttiina näkymättömälle lasersäteilylle. Älä katso säteeseen. (f)

1. CLASS 1 LASER PRODUCT
2. **DANGER:** Invisible laser radiation when open and interlock failed or defeated. Avoid direct exposure to beam.
3. **CAUTION:** Do not open the top cover. There are no user serviceable parts inside the Unit; leave all servicing to qualified service personnel.

1. PRODUCTO LÁSER CLASE 1
2. **PELIGRO:** En el interior hay radiación láser invisible. Evite el contacto directo con el haz.
3. **PRECAUCIÓN:** No abra la tapa superior. En el interior de la unidad no existen piezas reparables por el usuario; deje todo servicio técnico en manos de personal calificado.

1. PRODUTO LASER CLASSE 1
2. **PERIGO:** O laser emite uma radiação invisível que é perigosa, caso o aparelho esteja aberto e a trava inoperante ou danificada. Evite exposição direta ao feixe dos raios.
3. **CUIDADO:** Não abra a caixa do aparelho. Não existem peças reparáveis pelo usuário na parte interna da unidade. Solicite assistência técnica somente a pessoal técnico qualificado.

1. 一级雷射产品。
2. 危险：当内部锁定装置失效或者损坏后，打开盖板可能会产生不可见的雷射辐射。应避免受到光束直接照射。
3. 注意：请勿打开顶盖板。本机内部没有用户可自行维修的部件；所有维修工作应由有资格的人员完成。

١. صنف ١ منتج ليزري
٢. خطر: أشعة ليزرية غير مرئية عند الفتح والاعلاق الفاشل أو غير الصحيح. تجنب التعرض المباشر للأشعة.
٣. تحذير: لا تفتح الغطاء العلوي. ليس في داخل الجهاز أقسام بمستطاع المستخدم صيانتها! إعهد بكافة الأعمال الصيانية لفني مختص.

We would like to thank you for purchasing one of our JVC products. Before connecting this unit to the wall outlet, read the instructions carefully to ensure that you obtain the best possible performance. If you have any questions, consult your JVC dealer.

## Table of contents

<b>GENERAL INFORMATION</b> .....	<b>1</b>
Care and handling of compact discs .....	1
<b>BEFORE USING FOR THE FIRST TIME</b> .....	<b>2</b>
Basic connections .....	2
Connecting the player to a TV or amplifier/receiver using the Audio Video cable .....	2
Connecting the player to an amplifier/receiver equipped with the analog discrete inputs .....	2
Video out select .....	2
Connecting the AV COMPU LINK cable .....	3
Connecting the power cord .....	3
Installing batteries .....	3
Putting batteries in the remote control .....	3
<b>OVERVIEW OF CONTROLS</b> .....	<b>4</b>
Front panel .....	4
Remote control unit .....	5
<b>BASIC OPERATIONS</b> .....	<b>6</b>
Now you can play a variety of discs! .....	6
Overview of the two play modes .....	6
Triple disc tray usage .....	6
Display window .....	6
Preparation for playing .....	6
Inserting/removing disc(s) .....	7
Starting to play disc(s) .....	7
Using number keys .....	7
Stopping play .....	8
Pausing play .....	8
Skipping the track .....	8
Manual search .....	8
Slow-motion playback on the remote control unit .....	9
Using stereo headphones .....	9
Setting TV TYPE .....	9
Selecting the Dolby Surround mode .....	10
To adjust the output balance of speakers .....	10
Using the remote control .....	11
Presetting the remote control to operate your own TV .....	11
Using the SHIFT button on the remote control unit .....	11
Preset code table .....	12
<b>VARIOUS UNIQUE FUNCTIONS</b> .....	<b>13</b>
Various functions to enhance your enjoyment .....	13
Display of operations status .....	13
Programming the track sequence you want .....	13
Canceling a programmed track .....	13
Clearing a program .....	13
Repeating tracks .....	14
Randomly playing tracks .....	14
Playing back a track from the desired time .....	14
Playing a multiplex sound CD .....	15
Viewing the VIDEO INTRO .....	15
Programming during VIDEO INTRO .....	15
Viewing the highlights .....	16
Playback with the Bookmark function .....	17
Marking segments for later viewing with the Bookmark function .....	17
Using the BOOK DIGEST button .....	17
Using the B. SEARCH button .....	17
Canceling individual bookmarks .....	18
Canceling all bookmarks on individual discs .....	18
Using a microphone .....	19
Using a wired microphone .....	19
Adjusting music key .....	19
Adjusting echo effect .....	19
Vocal replace .....	20
Vocal effect .....	20
<b>OPERATION OF PLAYBACK CONTROL FUNCTION</b> .....	<b>21</b>
Playing Video CDs and SVCDs with Playback Control function .....	21
Video CDs and SVCDs with Playback Control function .....	22
<b>RESTRICTING USE OF YOUR DISCS</b> .....	<b>23</b>
Locking a disc with the Read-Protect function .....	23
Locking a disc .....	23
Canceling Read-Protect .....	23
Releasing the Read-Protect temporarily .....	23
<b>DIGITAL AUDIO CDs</b> .....	<b>24</b>
Playing Digital Audio CDs .....	24
Playing Digital Audio CDs .....	24
Unavailable functions for Audio CDs .....	24
<b>AV COMPU LINK REMOTE CONTROL SYSTEM</b> .....	<b>25</b>
AV COMPU LINK remote control system .....	25
Connection and setup .....	25
Operation .....	25
<b>SPECIFICATIONS</b> .....	<b>26</b>
Main specifications .....	26
<b>TROUBLESHOOTING</b> .....	<b>27</b>
Troubleshooting .....	27

# GENERAL INFORMATION

## Care and handling of compact discs

### How to handle CDs

When handling a compact disc, do not touch the surface of the disc (reflective silver side — the side without the label).

Since compact discs are made of plastic, they are easily damaged. If a disc gets dirty, dusty, scratched or warped, the sound will not be picked up correctly and, in addition, such a disc may cause the CD player to malfunction.

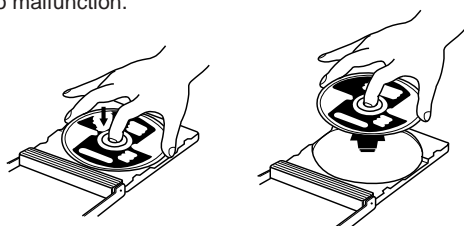

### Care of the label side

Do not damage the label side, stick paper to, or use any adhesive on its surface.

### Storage

Make sure that discs are kept in their cases. If discs are piled one on top of another without their protective cases, they can be damaged. Do not put discs in a location where they may be exposed to direct sunlight, or in a place where the humidity or temperature is high. Avoid leaving discs in your car!

### Maintenance of discs

If there are fingerprints or dirt adhering to a disc, wipe it with a soft dry cloth, moving from the center outwards.

If a disc is difficult to clean, wipe with a cloth moistened with water. Never use record cleaners, petrol, alcohol or any anti-static agents.

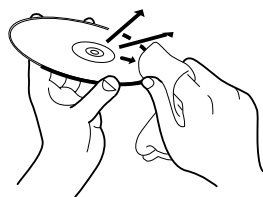

### CAUTION

Sometimes during play noise or images may be garbled. This is sometimes due to the disc. (It may not be up to industry standards.) These symptoms are caused by the discs, not by the malfunction of the player.

### Which compact discs can be used?

Many types of compact discs are sold for a variety of uses. The player can play the following compact discs:

- **SVCD (Super VCD) discs**

\* Better video resolution using MPEG2 and VBR (Variable Bit Rate) technologies.

\* Up to four languages can be included as subtitles or song lyrics.

\* Up to four languages can be included as audio.



- **Video CD discs both with and without PBC function**



PlayBack Control

- **Audio CD discs**



### Discs you can't play back

Any other discs than listed above (such as CD-ROM, DVD or CD-I discs) cannot be played. Playing back such discs may generate noise and damage your speakers.

\* Even though a logo listed above is printed on the disc, it may not be played if it is a non-standard disc.

### Using the remote control

The remote control is ready to use when its batteries are installed properly.

To use it, point its infrared light-emitting window toward the display window of the player and press a button. The operating range of the remote control is up to about seven meters in front of the player and within about 30 degrees to each side — with nothing between the remote control and the player interrupting the beam path.

If pressing a button on the remote control does not produce any response, check to make sure it is pointed correctly and try again. If it still does not function, check the batteries.

# BEFORE USING FOR THE FIRST TIME

## Basic connections

The Video CD player must be connected directly to a television set or, an amplifier or receiver that is connected to a television or monitor. Select a level, dry location free of dust and vibration, having a temperature maintained between 5 and 35°C (41 and 95°F).

### Connecting the player to a TV or amplifier/receiver using the Audio Video cable

First make the audio and video connections before connecting the AC power cord. Also, make sure that the equipment (television, amplifier or receiver) to be connected with the player is turned off.

Firmly insert the yellow pin plug of the Audio Video cable in the yellow VIDEO OUT jack on the rear panel of the player; the red pin plug in the red AUDIO OUT FRONT (RIGHT) jack; and the white pin plug in the white AUDIO OUT FRONT (LEFT) jack. (The RIGHT and LEFT output jacks are for the right and left audio channels.)

Then firmly insert the pin plugs at the other end of the Audio Video cable into the matching video and audio INPUT jacks.

If your television set has an S-video input, we recommend you to connect it with S-VIDEO OUT of the player using the optional S-Video cable, in addition to the (standard) video connection, to get a better picture quality.

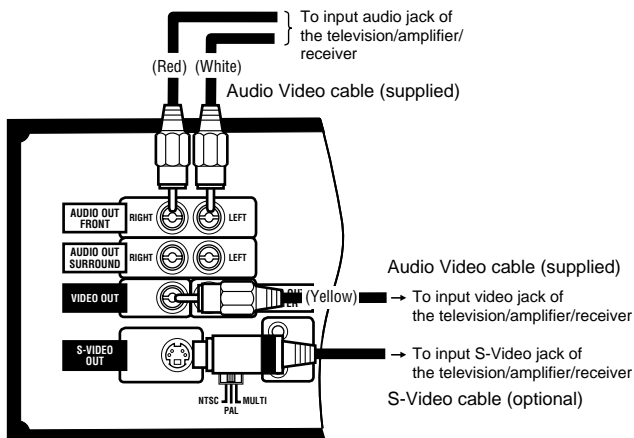

### Connecting the player to an amplifier/receiver equipped with the analog discrete inputs

Connect the player's 5-channel outputs (AUDIO OUT FRONT-RIGHT/LEFT, AUDIO OUT SURROUND-RIGHT/LEFT, and AUDIO OUT CENTER) to the analog discrete inputs of an amplifier/receiver using audio cables, while the VIDEO OUT to the television's video input terminal using the yellow plugs of the supplied Audio Video cable. Be sure to connect correctly between corresponding terminals.

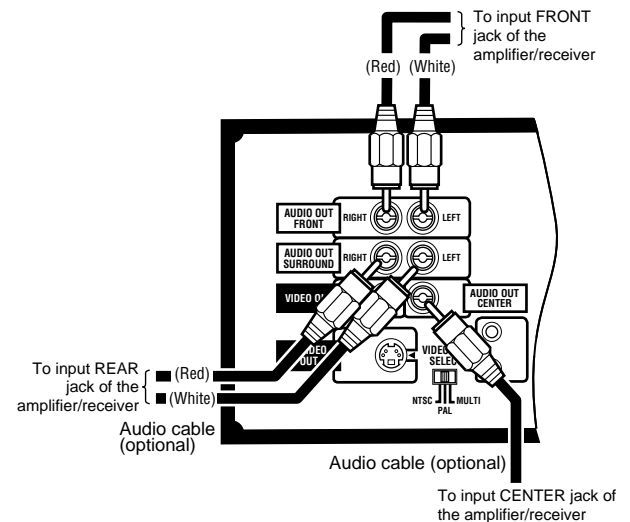

### Video out select

Set the VIDEO OUT SELECT switch on the rear panel to NTSC, PAL, or MULTI mode according to your television system.

- NTSC ..... for NTSC exclusive TV
- PAL ..... for PAL exclusive TV
- MULTI ..... for Multisystem TV

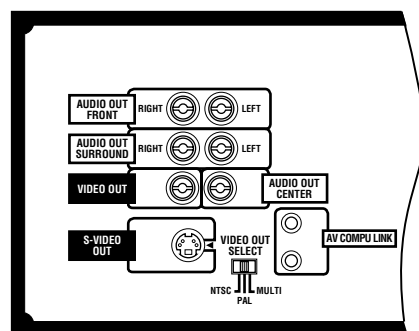

#### Note

- Set the switch before turning the power on. If you change the switch position while the power is on, the new setting does not become effective until you turn the power to standby and then on.

## Connecting the AV COMPU LINK cable

Connect with other JVC equipment supporting the AV CompuLink by using the supplied AV COMPU LINK cable to facilitate operations. See "AV COMPU LINK remote control system" on page 25.

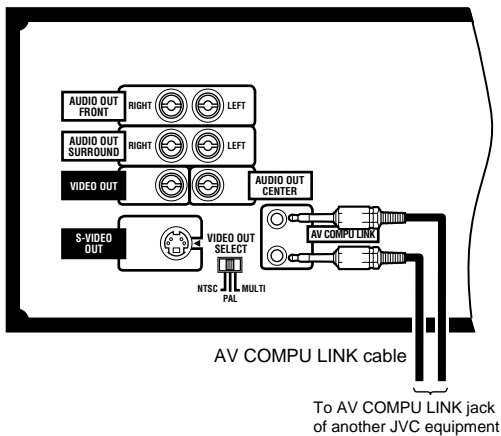

## Connecting the power cord

### IMPORTANT

Check the setting of the VOLTAGE SELECTOR switch on the rear panel of the player. Change the setting if the switch is not set for the main voltage supplied to your home.

After the audio-video connectors had been connected, insert the female end of the power cord firmly into the AC POWER CORD socket located on the rear panel of the player. Then insert the male end of the power cord into the wall outlet.

When the power is connected and the POWER ON/OFF button is depressed (ON), the STANDBY indicator on the left-hand side of the player's front panel comes on. See "Overview of Controls" for a description of the controls on the player.

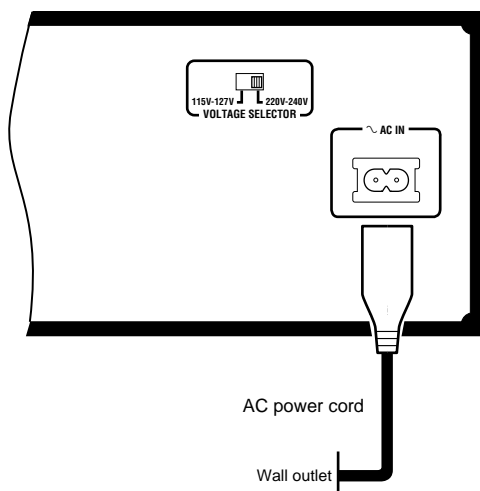

## Installing batteries

### Putting batteries in the remote control

The battery compartment is located on the back of the remote control.

1. Insert your finger in the recess under the battery compartment cover, and pull off the cover.

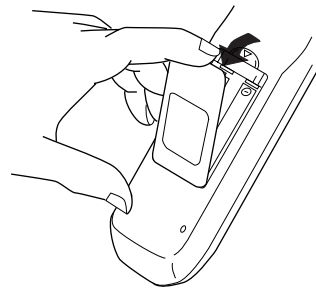

2. Place the two accessory R6P (SUM-3)/AA (15F) batteries in the remote control according to the polarity markings ("+" and "-") inside the compartment and on the batteries.

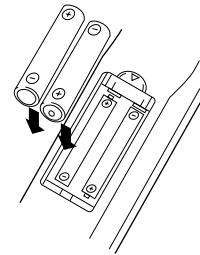

3. Insert the two tabs of the cover in their respective slots, and snap the cover in place.

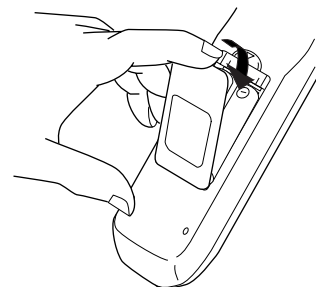

The batteries last about one year with normal use. If function of the remote control become erratic, replace the batteries.

### Precautions for the safe use of batteries

Observe the following precautions for the safe use of batteries. Their life will be shortened, they may burst or their contents may leak if they are used improperly.



# OVERVIEW OF CONTROLS

The following is an explanation of the basic function of controls on the front panel of the player and the remote control. The function of some controls may be restricted in actual use depending on the

on-going operations. The remote control has fourteen unique function buttons in addition to those on the player.

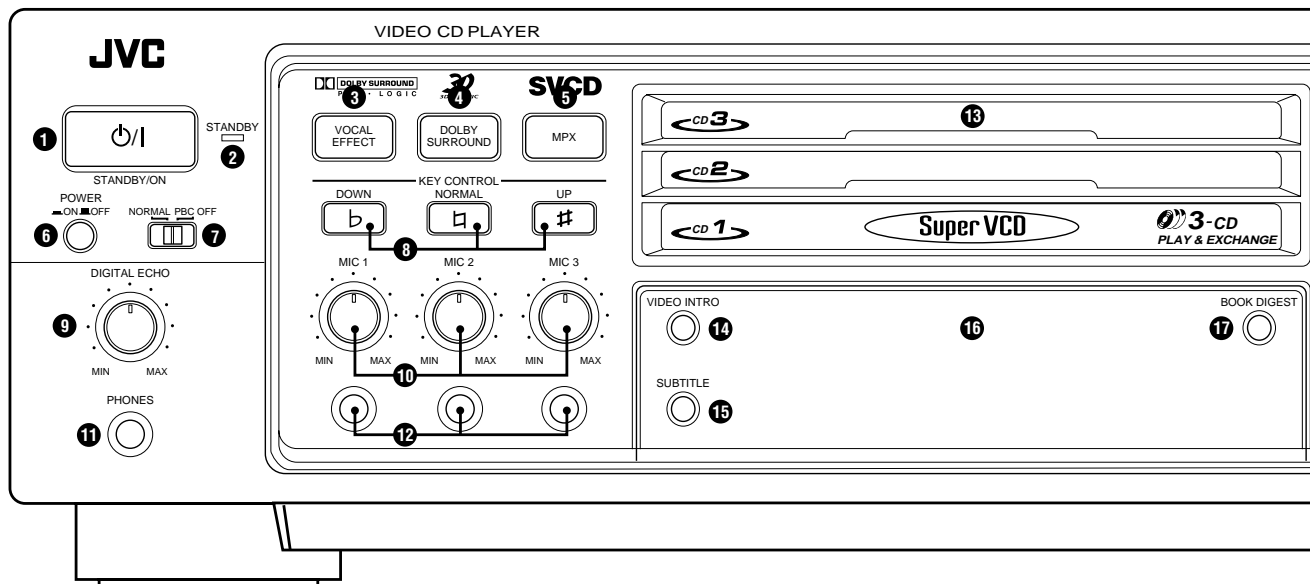

## Left front panel of the player

(Controls marked (R) have equivalents on the remote control.)

- 1** **⏻/I (STANDBY/ON) button (R)**  
Turns the player on or to STANDBY.
- 2** **STANDBY indicator (Red)**  
Lights when the POWER ON/OFF button is depressed and the player is in standby mode.
- 3** **VOCAL EFFECT button (R) with indicator (Green)**  
Selects the vocal effect mode for the microphone inputs (1 through 3). Pressing this button cycles the modes as shown below.  
HARMONY → CHORUS → FLANGE → OFF
- 4** **DOLBY SURROUND button (R) with indicator (Green)**  
Selects the Dolby surround mode. See page 10.
- 5** **MPX button (R) with indicator (Green)**  
Selects the audio channel(s) of a disc to be monitored. See "Playing a multiplex sound CD" on page 15.
- 6** **POWER ON/OFF button**  
Turns the power to standby or completely off.
- 7** **PLAY MODE switch**  
Switches between the NORMAL and PBC modes. It only affects Video CD and SVCD discs with PBC function.  
NORMAL: Allows use of the Playback Control (PBC) function.  
PBC OFF: Inhibits the PBC function.
- 8** **KEY CONTROL buttons (R) with indicator (Green)**  
Transposes the music key.  
DOWN ♭ button: used to flatten by a half tone.  
NORMAL ♮ button: returns to original key.  
UP # button: used to sharpen by a half tone.
- 9** **DIGITAL ECHO knob**  
Adjusts the degree of the echo effect for the microphone (1 through 3) voice.
- 10** **MIC 1 to MIC 3 knobs**  
Adjusts volume of the microphone corresponding to MIC number.
- 11** **PHONE jack**  
Used for connecting stereo headphones. The volume is set to a predetermined level and is not adjustable.
- 12** **MIC jacks (1 through 3)**  
Used for connecting microphones (1 through 3). The jacks correspond to MIC 1 to 3 volume knobs located above.

## Center front panel of the player

- 13** **CD1 to CD3 trays**  
Used to load discs. To insert/remove discs, press the ▲ (OPEN/CLOSE) button located at the right of the tray corresponding to disc number.
- 14** **VIDEO INTRO button (R)**  
Applies to Video CD and SVCD discs only. The introductory several seconds of tracks on a disc are displayed on the television screen in order to present the contents of the disc.
- 15** **SUBTITLE button (R)**  
Effective only when playing back an SVCD disc. SVCD discs may have up to four subtitles which you can select to see on the TV screen (as an optional feature). Pressing this button cycles the subtitles as shown below.  
Subtitle 1 → Subtitle 2 → Subtitle 3 → Subtitle 4 → OFF
- 16** **Display window**  
Shows information about the status of operation.
- 17** **BOOK DIGEST button (R)**  
Displays video segments you marked with the Bookmark function. See page 17.

## Right front panel of the player

- 18** **▲ (OPEN/CLOSE) buttons (CD number 1 to 3)**  
Used to open and close disc trays 1 to 3 respectively. When, after opening the CD1 tray, another ▲ (OPEN/CLOSE) button is pressed, the CD1 tray is first closed, then the other CD tray selected is opened.
- 19** **CD1 through CD3 buttons (R) with indicators (Green)**  
Plays the disc of the number indicated on the button. As soon as the disc begins playing, the indicator blinks.
- 20** **⏪ RETURN button (R)**  
Utilized for operation with the PBC function. This button is used to return to a menu screen during play.
- 21** **⏸ (PAUSE)/STILL button (R)**  
Temporarily suspends playing. Video motion freezes and audio reproduction stops. Pressing the button repeatedly advances the picture frame-by-frame. (Video CD and SVCD only)
- 22** **BOOKMARK button (R) with indicator (Green)**  
Places a "bookmark" at video segments you want to find later for almost instant replay. See page 17.
- 23** **B. SEARCH button (R) with indicator (Green)**  
Retrieves video segments which you marked with a bookmark. See page 17.



The controls with identical names on the player and on the remote control have the same function and are used in the same manner.

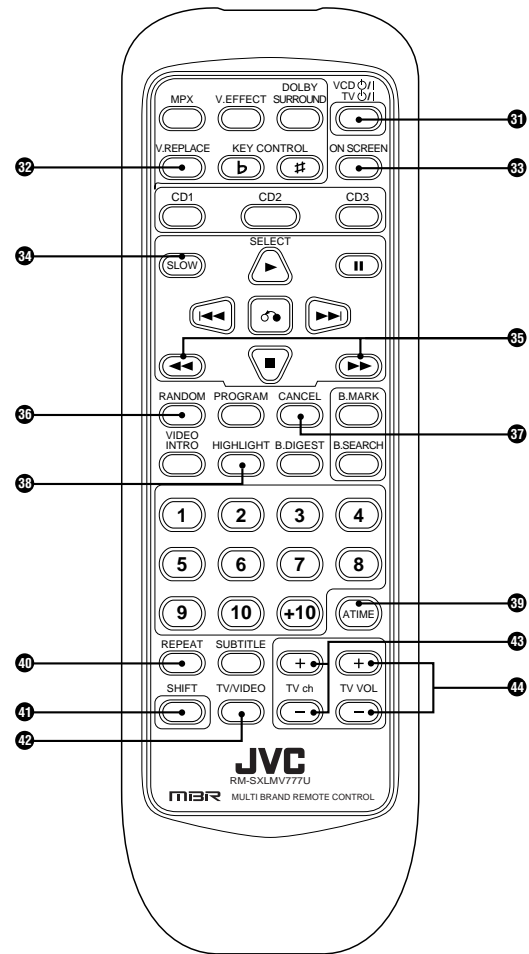
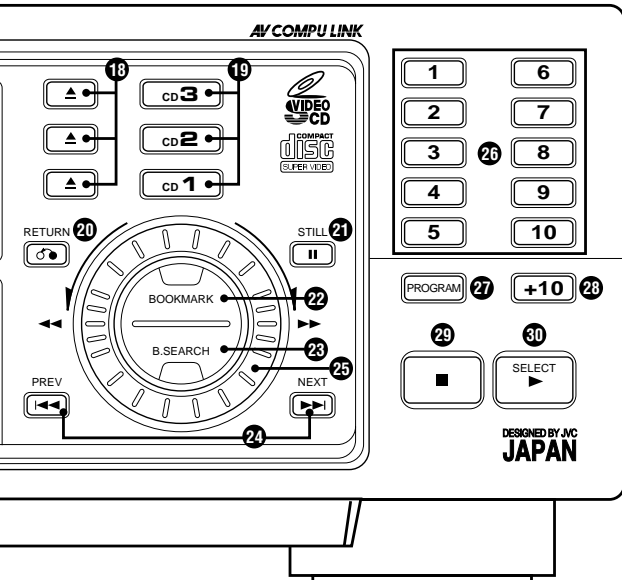

- 24** **◀◀ / ▶▶ PREV / NEXT buttons (R)**  
 During operation with the Playback Control function  
 Invokes previous or next screen.  
 During operation without the Playback Control function  
 Used to skip track(s) forward or backward from the current track being played, or to shift the playing location backward or forward quickly.
- 25** **Jog/Shuttle dial**  
 Used to play forward or backward quickly.
- 26** **Number keys (1 to 10) (R)**  
 Used to specify a track number for playing or programming.  
 To select a number between 1 and 10, press the corresponding key for the number. To select a number higher than 10, use the +10 key. The maximum number you can specify is 99.  
 See "Using number keys" on page 7 for the examples.  
 These keys are also used to select a menu item number. See also "Operation of Playback Control function" on page 21.
- 27** **PROGRAM button (R)**  
 Any desired sequence of tracks can be programmed with the number keys and the +10 button. (On the remote control use +10)  
 The program button cannot be used while the Playback Control function is activated.
- 28** **+10 button (R)**  
 Used when specifying a number which is higher than 11. See "26 Number keys" above and "Operation of Playback Control function" on page 21.
- 29** **■ (STOP) button (R)**  
 Stops play.
- 30** **▶ (PLAY)/SELECT button (R)**  
 Starts to play the disc.

**Remote control unit**

- 31** **VCD  $\odot$ /I /TV  $\odot$ /I button**  
 Turns the player on and to STANDBY.  
 When pressed after you hold down the SHIFT button, turns the TV on or off.
- 32** **V.REPLACE button**  
 Activates the vocal replace function, inserting your voice in place of the disc vocals.
- 33** **ON SCREEN button**  
 Controls whether or not control and operation status are displayed on the television screen or monitor.
- 34** **SLOW button**  
 Starts slow-motion playback.
- 35** **◀◀ / ▶▶ MANUAL SEARCH button**  
 Shifts the playing location backward and forward quickly. Holding down the button causes it to go much faster.
- 36** **RANDOM button**  
 Changes the disc track program to a random sequence from disc 1 through 3 respectively.
- 37** **CANCEL button**  
 Cancels the latest track you have programmed. The latest programmed track is canceled whenever you press this button. Also used to cancel a bookmark.
- 38** **HIGHLIGHT button**  
 Applies to a video CD and SVCD discs to see highlights of a track. Displays the several seconds of each of nine equal-time segments of the track.
- 39** **ATIME button**  
 Used to play back a disc track from the desired time. See page 14.
- 40** **REPEAT button**  
 Repeats a track or inserted discs from 1 to 3.
- 41** **SHIFT button**  
 Used together with other keys for various functions. See page 11.
- 42** **TV/VIDEO button**  
 Sets the input mode of the TV. Also used to preset the remote control unit, to control some functions on your TV set. See page 11.
- 43** **TV ch - / TV ch + keys**  
 Changes the television channel.
- 44** **TV VOL + / TV VOL - keys**  
 Turns the TV volume up or down.

# BASIC OPERATIONS

Now you can play a variety of discs!!

## Overview of the two play modes

The player has two play modes for Video CD and SVCD discs. These are selected by the PLAY MODE switch on the left side of the front panel.



- NORMAL:** Allows use of the Playback Control (PBC) function.
- PBC OFF:** Inhibits the PBC function.

It only affects Video CD and SVCD discs with PBC function.

## Triple disc tray usage

Up to three discs can be loaded in the player. You may insert a disc into any of the disc trays 1 through 3.

If you want to play only a specified disc, press the corresponding CD 1, 2 or 3 button located to the right of the ▲ (OPEN/CLOSE) button.

When three discs are inserted, basic order of playing is as follows.

- Pressing CD 1: CD 1 → CD 2 → CD 3 → STOP
- Pressing CD 2: CD 2 → CD 3 → CD 1 → STOP
- Pressing CD 3: CD 3 → CD 1 → CD 2 → STOP

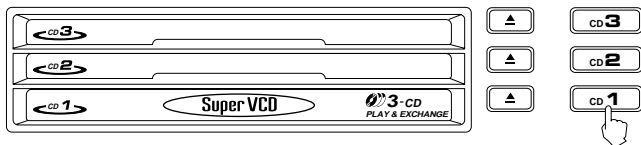

## Display window

The display window indicates many aspects of control and operation status.

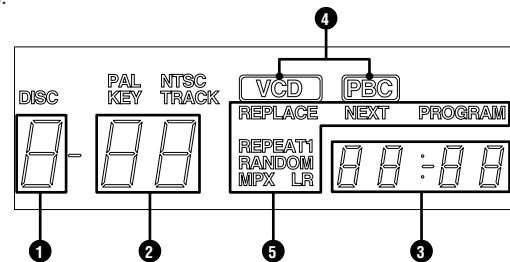

- 1 Shows the disc number being played.
- 2 Shows mainly the total number of tracks and the track number being played.
- 3 Mainly shows the cumulative time (minutes and seconds) of the track when the player is playing. It also shows the total time of the disc for about ten seconds after the player stops playback, or finishes reading the disc information when a disc has been inserted.
- 4 Shows the type of disc being played.
- 5 Each indicator in this area lights when the corresponding function is activated.

## Preparation for playing

Turn on the television set, amplifier or receiver to which the player is connected. Then set the channel and modes properly to accept the player's output signal.

### CAUTION

Set the sound volume of the television set, amplifier or receiver to which the player is connected to a reasonable level before starting playback.

Press the POWER ON/OFF button.



Press the button on the front panel or the VCD (TV ) button on remote control. The STANDBY indicator goes out.

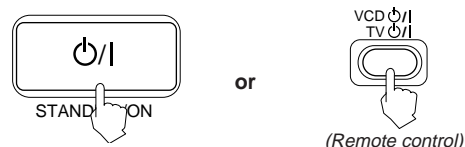

The display window shows the initial information as shown below.

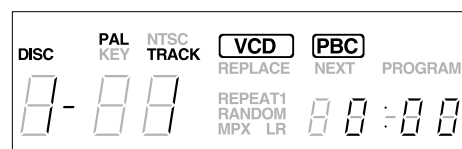

## Inserting/removing disc(s)

Press the ▲ (OPEN/CLOSE) button (1 through 3) to open the disc tray. Then place the disc in the round recess of the tray with label side up. To close the tray, press the ▲ (OPEN/CLOSE) button again.

If you press the ▲ (OPEN/CLOSE) button of the disc which is playing, the player stops and then opens the tray.

If you press the ▲ (OPEN/CLOSE) button of a disc that is not being played, you can change discs without stopping play.

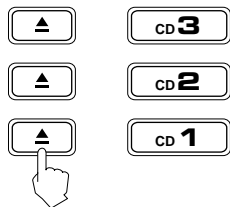

### Note

- When loading a disc in the disc tray, be sure to position the disc inside the recess. Otherwise, the disc will be damaged when the disc tray is closed, and the disc cannot be removed from the unit.

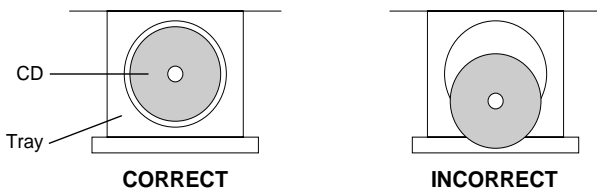

## Starting to play disc(s)

Press the ► (PLAY)/SELECT button. The player starts to play from the disc indicated in the display window.

Or, press one of the CD 1 through 3 buttons to start to play the corresponding disc.



or

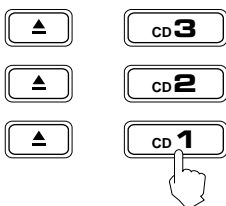
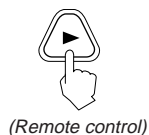

or

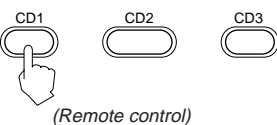

If the PBC function is activated, the display window shows "Pb" and the menu is displayed on the television screen. See page 21 for the "operation of PBC function".

If the PBC function is not activated, the player starts playback from the first track of the disc.

- For individual track selection, use the number keys (see the explanation below) or the ◀◀ / ▶▶ buttons.
- During playback, the display window shows the disc number and the track number being played.
- When you press ► button during play, the disc will restart from the beginning of the track.

## Using number keys

If the PBC function is not activated, you can select a track number by using the numeric keys.

On the player ..... 1 to 10 and +10 key

Example: For number 5, press 5. For number 15, press +10, then 5. For number 20, press +10, then 10. For number 32, press +10 three times, then 2.

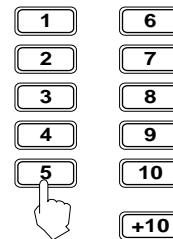

On the remote control ..... 1 to 10 and +10 key

Select numbers as described above.

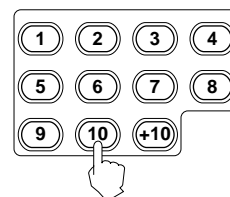

### Note

- When you select the track using the number keys, the track will start playing without pressing ► (PLAY)/SELECT button.

## Stopping play

Press the ■ (STOP) button to stop play at any time.

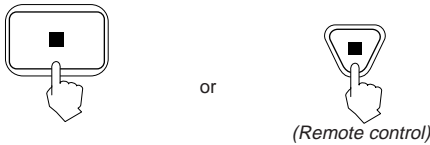

## Pausing play

Press the || (PAUSE)/STILL button to temporarily suspend play.

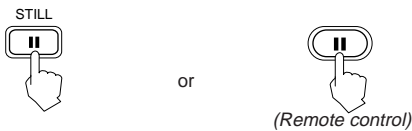

### Notes

- When the || (PAUSE)/STILL button is pressed once, "PAUSE" appears on the television screen, the video motion freezes and the sound is turned off. The still picture advances frame-by-frame each time the || (PAUSE)/STILL button is pressed. This frame-by-frame function is available only for Video CDs and SVCDs.
- To release the pause, press the ► (PLAY)/SELECT or blinking CD 1 through 3 button.
- During "PAUSE" the time counter on the display will blink.

## Skipping the track

If the PBC function is not activated, you can skip track(s) by using the ◀◀ / ▶▶ buttons during play.

Pressing the ◀◀ button skips the current track backward, while pressing ▶▶ skips forward.

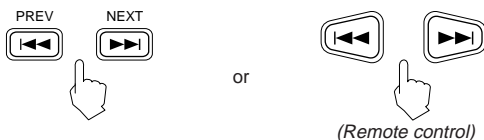

## Manual search

During play, you can search the disc position by using the shuttle dial, or ◀◀ / ▶▶ buttons on the player or ◀◀ / ▶▶ buttons on the remote control unit.

Rotating the shuttle dial to the right causes the disc to play forward quickly. Rotating it to the left causes it to play backward quickly.

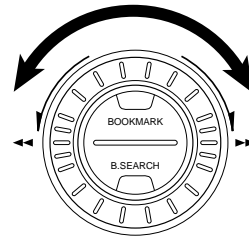

Holding down the ◀◀ / ▶▶ buttons on the player or the ◀◀ / ▶▶ buttons on the remote control unit causes the disc to play forward or backward quickly.

Continuing to hold down the buttons causes it to search much faster.

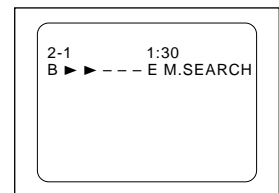
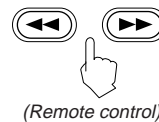

(Television screen)

### Notes

- In some circumstances, this function is not available when the PBC function is activated.
- The angle at which you hold the shuttle dial determines the manual search speed.

## Slow-motion playback on the remote control unit

Press the SLOW button to play in slow-motion. By pressing the SLOW button consecutively, the playback speeds are cycled as shown below.

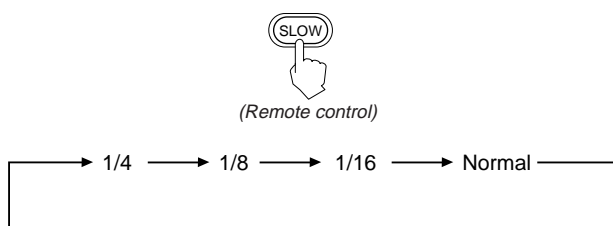

### Note

- This function can only be used when playing a video CD or SVCD.

## Using stereo headphones

### Connecting stereo headphones

Connect stereo headphones to the PHONES jack at the lower-left of the front panel. The volume level is fixed and cannot be adjusted.

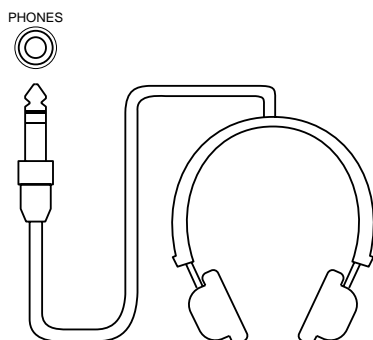

## Setting TV TYPE

To playback SVCD discs which are recorded for wide-screen televisions correctly, select the TV TYPE to match your television.

### Operation

- While the player is in stop mode, press and hold the RETURN button until the following display appears on the television screen.

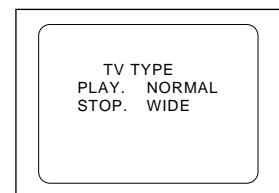

- If your television is a normal television, press the (PLAY)/SELECT button of the player to select NORMAL. If your television is a wide-screen television, press the (STOP) button of the player to select WIDE.

The following display appears.



- Press the (PLAY)/SELECT button to complete the setting. Pressing the (STOP) button returns to the previous display for selection.

### Notes

- The TV TYPE setting is effective for SVCD discs recorded for wide-screen television.
- The initial setting is NORMAL.
- Once the TV TYPE is set and memorized, it does not disappear by turning the player to standby mode or completely off.

## Selecting the Dolby Surround mode

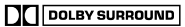
You can enjoy the surround sound with discs bearing the mark .

### Preparation

- If your system is ready for the Dolby Pro Logic, make the connection between the player and your amplifier/receiver correctly according to "Basic connections" on page 2.
- Even if your audio system is for a normal stereo reproduction, including a stereo amplifier/receiver and two speakers, you can enjoy the pseudo-surround sound with 3D Phonic mode.

### Operation

To select the Dolby Surround mode, use the **DOLBY SURROUND** button. Pressing this button cycles the modes as shown below.

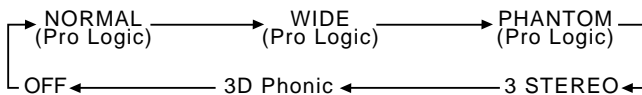

When any mode but OFF is selected, the **DOLBY SURROUND** button lights.

Select the mode depending on your system configuration.

#### NORMAL (Pro Logic):

Select this mode when the center speaker cannot reproduce the bass better than the front speakers. The bass portions of the center channel signals are output through the front speakers.

#### WIDE (Pro Logic):

Select this mode when the center speaker can reproduce the bass better than the front speakers. All signals of the center channel are output through the center speaker.

#### PHANTOM (Pro Logic):

Select this mode when you do not use a center speaker. The center speaker channel signals are output through the front speakers.

#### 3 STEREO:

Select this mode when a center speaker is connected without rear speakers.

#### 3D Phonic:

Select this mode when reproducing the surround sound with only two front speakers. It gives you very realistic surround effect as if the sound is reproduced through the Dolby Surround decoder.

This mode is the result of research on sound localization technology carried out at JVC for many years and make it possible to reproduce the surround sound with only two front speakers.

\* Manufactured under license from Dolby Laboratories. "Dolby", "Pro Logic", and the double-D symbol are trademarks of Dolby Laboratories.

## To adjust the output balance of speakers

1. Set the Dolby Surround mode to any one of **NORMAL**, **WIDE**, **PHANTOM** and **3 STEREO**.
2. In stop mode, press the **SUBTITLE** button on the player repeatedly until the following display appears on the television screen.

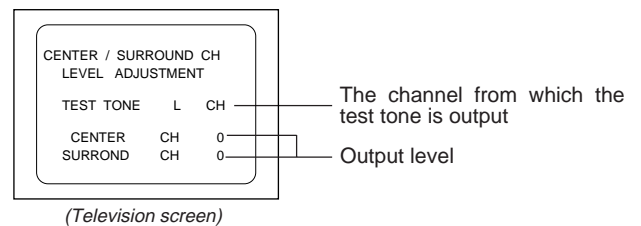

The test tone is output from speakers in the following order.

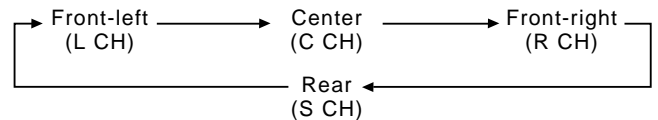

See whether you hear the test tone from each speaker in the same level at the listening position.

3. If any adjustment is necessary, press the **DOLBY SURROUND** button to select the channel (**CENTER** or **SURROUND**) to be adjusted. The selected channel turns yellow.
4. Each press of the **UP (#)** button on the player or remote control unit increases the output level up to +10 dB. Each press of the **DOWN (b)** button on the player or remote control unit decreases the output level up to -10 dB.
5. Pressing the **SUBTITLE** button on the player or remote control unit completes the adjustment.

The setting is memorized and will not disappear even if the player turns to the standby mode or completely off.

When setting the Dolby Surround mode to **PHANTOM**, **CENTER** cannot be adjusted.

When setting the Dolby Surround mode to **3 STEREO**, **SURROUND** cannot be adjusted.



## Using the remote control

### Presetting the remote control to operate your own TV

You can use the player's remote control unit to control some functions on your TV set (e.g., turning the TV on and off, adjusting volume, or selecting channels). First, though, you must preset the remote control to make it compatible with your TV.

#### Operation

1. Check the Preset Code Table (page 12) to determine the two-digit brand code number for your TV.
2. While holding down the TV/VIDEO button on the remote control, press the number keys to insert the two-digit brand code number. (For example, if the code number is "28", press the number key 2, then 8. If the first digit is a "0", press 10. Thus, if the code number is "09", press the number key 10, then 9. If the code number is "10", press the number key 1, then 10. If it is "20", press the number key 2, then 10.)

#### Notes

- Before the remote control unit leaves the factory, the brand code number is set as No. 01 (JVC).
- Depending on your television set's age and other factors, brand code numbers may be different from those shown in the table. In such a case, try out other codes until you find one that corresponds to your television.

3. While still holding down the TV/VIDEO button, press the ■ (STOP) button on the remote control.



4. The TV is turned off if the code number is correct. Repeat the procedure from the beginning if you weren't successful the first time.

### Using the SHIFT button on the remote control unit

You can control other functions with the remote control, simply by pressing a button while holding down the SHIFT button. Some of these functions are useful for Karaoke and Video CD playing, others for controlling the TV.



#### ■ SHIFT button functions to control the TV

SHIFT + VCD  ⇒ Turns the TV on and off

SHIFT + A TIME ⇒ TV MUTE (Mute the TV sound)

SHIFT + 1 ⇒ TV Channel 1

SHIFT + 2 ⇒ TV Channel 2

⋮

SHIFT + 10 ⇒ TV Channel 0\*

SHIFT + REPEAT ⇒ 1 - (The first digit of a TV Channel number 10 to 19. Push a number key to insert the second digit.)\*

SHIFT + SUBTITLE ⇒ 2 - (The first digit of a TV Channel number 20 to 29. Push a number key to insert the second digit.)\*

SHIFT + +10 ⇒ -/- - (To change a one - digit or to change a two - digit TV channel number, using a number key.)\*

SHIFT + B. SEARCH ⇒ ENTER (Push after choosing a channel. This function registers the channel you have chosen.)\*

#### Note

- The asterisk \* indicates that these operations do not work for some manufacturers' television sets.

---

## BASIC OPERATIONS

### Preset code table

---

No.	Television manufacturer
01	JVC
02	PANASONIC
03	SONY
04	SHARP
05	TOSHIBA/BEIJING/CHANGHONG
06	mitsubishi/CHANGHONG
07	HITACHI
08	SANYO
09	FUNAI
10	AIWA
11	DAEWOO
12	SAMSUNG
13	LG (GOLDSTAR)
14	THOMSON
15	FERGUSON
16	PHILIPS/TCL/CHANGHONG
17	GRUNDIG
18	ITT
19	MIVER
20	FINLUX
21	NOKIA
22	NEC
23	JINXING/PEONY1
24	PEONY2
25	PEONY3/CHANGHONG
26	KONKA
27	PEIJIN/NOBLEX
28	TCL

# VARIOUS UNIQUE FUNCTIONS

## Various functions to enhance your enjoyment

### Display of operations status

#### Preparation

This function is controlled by the remote control.

#### Operation

Press the ON SCREEN button on the remote control. By pressing the ON SCREEN button, the following information may be easily and quickly displayed or removed from the television screen.

Time, Echo effect, Key control, Program, Repeat, Random, Multiplexing, Vocal effect, DOLBY SURROUND, Vocal replace, Bookmark, etc.

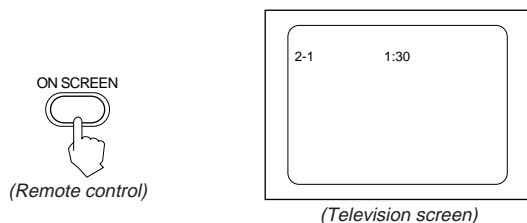

### Programming the track sequence you want

#### Preparation

It is not possible to enter programming mode during play. If playing, stop the player with the ■ (STOP) button.

#### Operation

1. Press the PROGRAM button to enter the programming mode. PROGRAM is displayed in the display window.

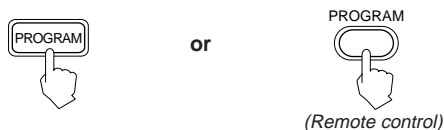

- Specify the disc by a CD (1-3) button and then the track by the number keys. You can program up to nine tracks by repeating this procedure.
- To play the programmed tracks press the ► (PLAY)/SELECT button.

#### Notes

- The track number playing, next track programmed, and number of programmed tracks are displayed from the left-top of the television screen. You may use the ON SCREEN button to delete this information.
- Once the programmed track is played, it is deleted from the program.
- You may also program additional tracks during the program playback as long as the number of the programmed tracks does not exceed nine.

To stop the program playback, press the ■ (STOP) button. Pressing the ► (PLAY)/SELECT button again causes the player to start playing from the next programmed track.

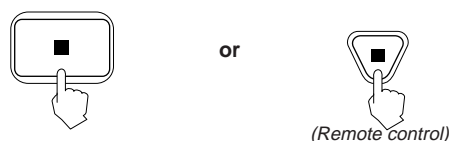

### Canceling a programmed track

#### Operation

There are two canceling functions (canceling the last programmed track and canceling the current track).

- To cancel the last programmed track, press the CANCEL button on the remote control and the last programmed track will be canceled. This can be done both in playback and stop modes.

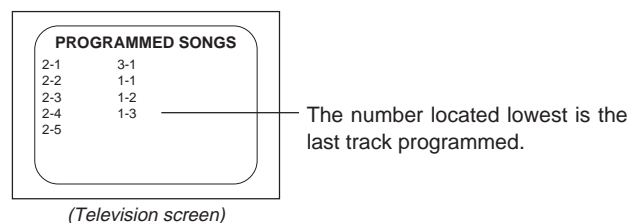

- To cancel the current track (during playback):
  - \* press the ■ (STOP) button to stop playback. The next press of the ► (PLAY)/SELECT button will start playback from the next programmed track.
  - \* press the ►| button to skip to the next programmed track.

#### Note

- To verify the tracks you programmed, stop the player and see ON SCREEN information.

### Clearing a program

To delete all programmed tracks you have entered, press the ■ (STOP) button and then the PROGRAM button while the player is in stop mode. "PROG OFF" will be displayed on the television screen.

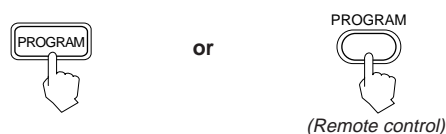

## VARIOUS UNIQUE FUNCTIONS

### Repeating tracks

It is possible to repeat playback of all discs or only a single track.

#### Preparation

This function is controlled by the remote control.

#### Operation

By pressing the REPEAT button on the Remote Control, REPEAT modes are cycled as shown below.

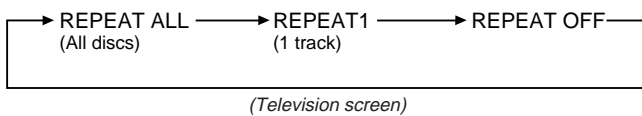

#### Notes

- When playing a programmed sequence of tracks, only one track repeat is available.
- The Repeat function is not available when a Video CD or SVCD disc with PBC is inserted and the PLAY MODE switch is set to NORMAL.
- Only REPEAT ALL is available when the player is in RANDOM mode.
- You cannot repeat the segment between bookmarks.

### Randomly playing tracks

#### Preparations

- This function is controlled by the remote control.
- This function plays tracks randomly from one disc.
- This function is available while the player is in stop mode.

#### Operation

Press the RANDOM button and random playing will start.

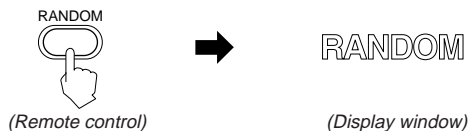

To stop the random playback, press the ■ (STOP) button.

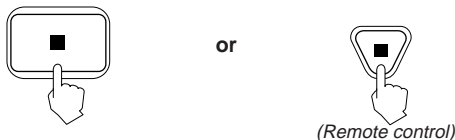

To cancel the random playback, press the RANDOM button again after stopping the player.



#### Note

- Random is not effective in program mode.

### Playing back a track from the desired time

You can play back a disc track from the desired time.

#### Operation

While playing back the desired track, operate the following procedures.

1. Press the ATIME button on the remote control.



2. Enter the desired time by pressing the corresponding number keys from left to right digits.

“10” button is used for “0” entry.

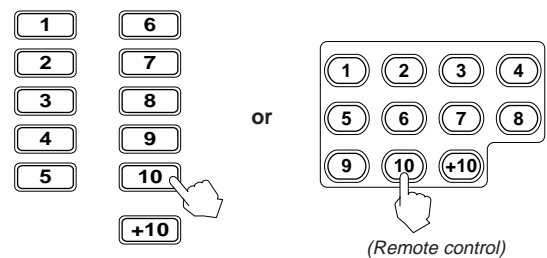

3. Press the ► (PLAY)/SELECT button.

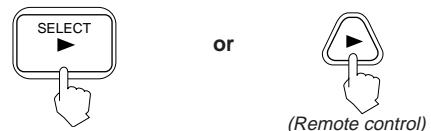

The disc will start playback from the specified time.

For example, if you want to play back the disc from “05m06s”, press the following buttons.

ATIME → 5 → 10 → 6 → ►

#### Note

- Some discs may not be played back from the specified time precisely.

## Playing a multiplex sound CD

This function is used for multiplex sound discs.  
See manuals attached to discs for detail information.

### Operation

By pressing the MPX button consecutively, channel multiplexing modes are cycled as shown below.

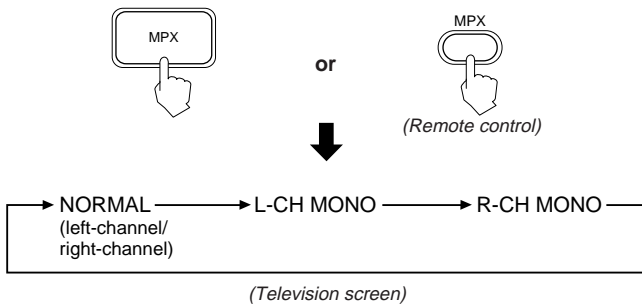

When L-CH MONO or R-CH MONO is selected, the MPX button on the player lights and the display indicates MPX L or MPX R respectively.

\* When playing back an SVCD;

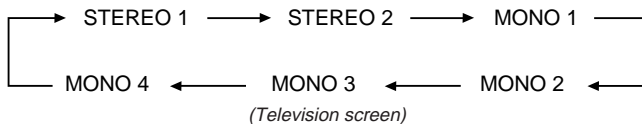

When any of MONO 1 through 4 is selected, the MPX button lights.

### Note

- Note that you can hear no audible sound at the STEREO 2, MONO 3 and MONO 4 positions if no audio is recorded on STEREO 2.

## Viewing the VIDEO INTRO

### Preparation

When you play a Video CD or SVCD with the Playback Control function, the PLAY MODE switch should be set to PBC OFF.

### Operation

- Play the disc you want to see a digest of.
- Press the VIDEO INTRO button on the player or the remote control just after starting disc play. Then, the player starts to display in sequence the first several seconds and track numbers of all tracks on the disc.

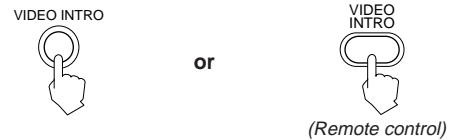

- To select a track during the video intro mode, press the number key corresponding to the item number on the television screen.

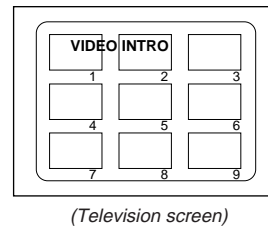

(Television screen)

### Note

- The Video intro function is not available in the Random mode.

## Programming during VIDEO INTRO

### Operation

- Stop play.
- Press the PROGRAM button so that PROGRAM is lit in the display.
- Press the disc button you want to play, and enter 1 on the number keys.
- Press the ► (PLAY)/SELECT button and then, after the disc has started to play, press the VIDEO INTRO button.
- The player starts to display in sequence the first several seconds and track numbers of all tracks on the disc. Select the numbers you want to program. You can program nine tracks.
- Press the ► (PLAY)/SELECT button to play.

### Viewing the highlights

This function is used for a movie Video CD or SVCD.

#### Preparations

- When you play a Video CD or SVCD with the Playback Control function, the PLAY MODE switch should be set to PBC OFF.
- This function is controlled by the remote control unit.

#### Operation

1. Start playing the track you want to see the highlights of.
2. After the track begins to play, press the HIGHLIGHT button on the remote control.

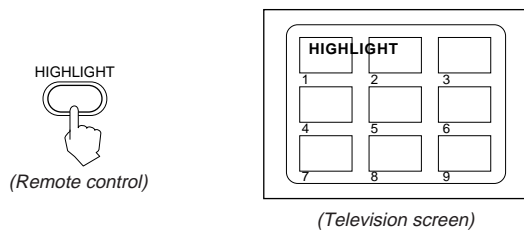

3. To select one of the nine segments, press the number key (1 to 9) of the segment which you want to play.  
The segment will start from several seconds before the shown time below each segment.

#### Notes

- The segments are each of nine equal-time divisions of the track.
- Nine different highlights are displayed for one minute.
- If no number key is pressed for a minute after the Highlight view appears on the screen, the screen is replaced with the Highlight view of the next track.
- While in VIDEO INTRO or HIGHLIGHT, sometimes the image is partially distorted. This symptom is caused by noise in the disc itself or incorrect manufacturing, not by a malfunction of the player.



# Playback with the Bookmark function

## Marking segments for later viewing with the Bookmark function

The Bookmark function lets you mark segments of a Video CD or SVCD, so that you can have almost instant playback of desired scenes later. You can mark segments on up to ten discs, with a maximum of nine segments per disc.

Even if you take the disc out of the player, its bookmarks will stay stored for later use, until you erase them.

### Operation

While playing the disc, press the **BOOKMARK** button at the segments you want to mark for later playing. Bookmark numbers appear on the television screen and the **BOOKMARK** indicator on the player flashes.

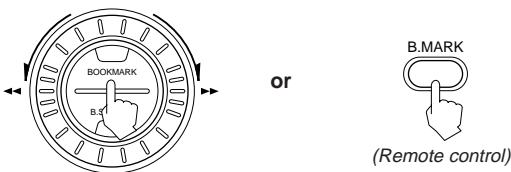

### Notes

- The Bookmark function works only with Video CDs and SVCD.
- The Bookmark function is most easily used when the player is in PBC OFF mode.
- When you begin marking segments in either NORMAL or PBC OFF mode, all subsequent markings and searches for that disc must be done in the same mode.

## Using the BOOK DIGEST button

1. Press the **BOOK DIGEST** button while playing the disc.

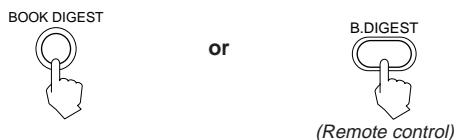

2. The marked segments will be highlighted on the screen, with their respective numbers (maximum of nine).
3. Press the number key (1 to 9) which corresponds to the number of the segment where you want to start play.

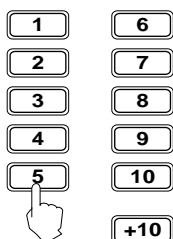

### Note

- The Bookmark Digest function is not available in PBC function.

## Using the B. SEARCH button

### ■ With PBC off

1. Press the **B. SEARCH** button. The **B. SEARCH** light will flash on and off, indicating the player is in the **Bookmark Search** mode.

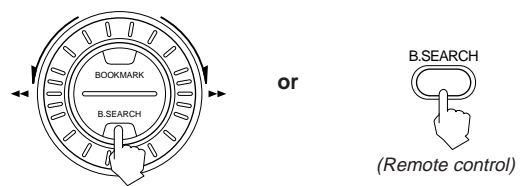

2. Press the number key (1 to 9) which corresponds to the number of the segment where you want to start play. While playing the disc, you can also use the **◀◀** or **▶▶** button to select the desired bookmark number.

### Note

- To exit the **Bookmark Search** mode and return to regular viewing, press the **B. SEARCH** button again.

### ■ With PBC on

1. Press the **B. SEARCH** button to enter **Bookmark Search** mode. If you press the button while playing, the player will stop and then enter **Bookmark Search** mode.

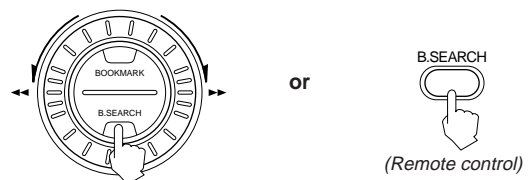

2. Press the number key (1 to 9) which corresponds to the number of the segment where you want to start play.

### Note

- The **Bookmark Search** function ends automatically, and the player returns to regular viewing.

**Canceling individual bookmarks**

■ **Canceling bookmarks set in PBC OFF mode**

**[Method A]**

1. In PBC OFF mode, start playing the segment whose bookmark you want to cancel.
2. Press the CANCEL button on the remote control unit. The bookmark for the segment immediately preceding the part you are playing will be canceled.

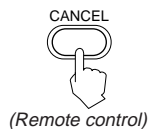

**Note**

- When you cancel a bookmark number, all subsequent bookmark numbers change, moving up one level to fill the gap you made.

**[Method B]**

1. Start playing in NORMAL mode.
2. Press the CANCEL button on the remote control unit. The bookmark with the highest number will be canceled (regardless of the playing position).

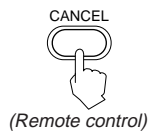

■ **Canceling bookmarks set in NORMAL mode**

1. Start playing in either NORMAL or PBC OFF mode.
2. Press the CANCEL button on the remote control unit. The bookmark with the highest number will be canceled (regardless of the playing position).

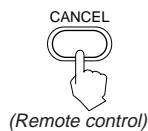

**Canceling all bookmarks on individual discs**

■ **Canceling bookmarks on a disc in the player**

You can cancel bookmarks on the currently selected disc in the player using the **|| (PAUSE)/STILL** button on the player.

In stop mode, press the **|| (PAUSE)/STILL** button on the player until bookmark information on the television screen stops blinking.

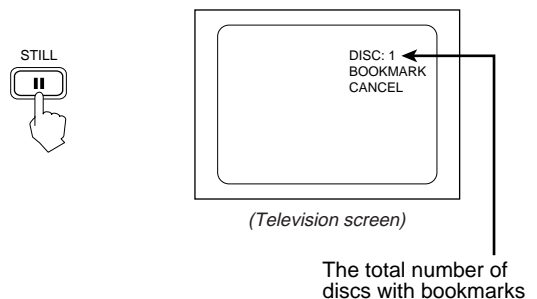

■ **Canceling bookmarks on a disc which was played the earliest**

You can cancel bookmarks on a disc you played the earliest whether it is in the player or not.

In stop mode, press the **■ (STOP)** button on the player until bookmark information on the television screen stops blinking.

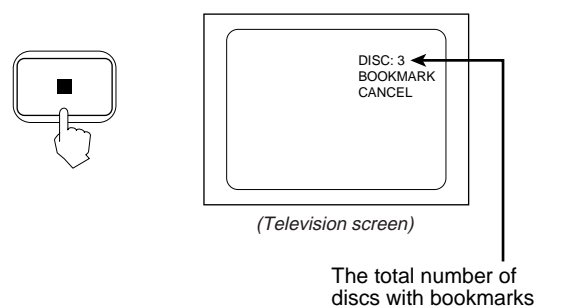

**Note**

- You can also cancel all bookmark information by setting the POWER button to OFF.

# Using a microphone

## Using a wired microphone

### Operation

Up to three microphones can be connected to the MIC jacks on the front panel.

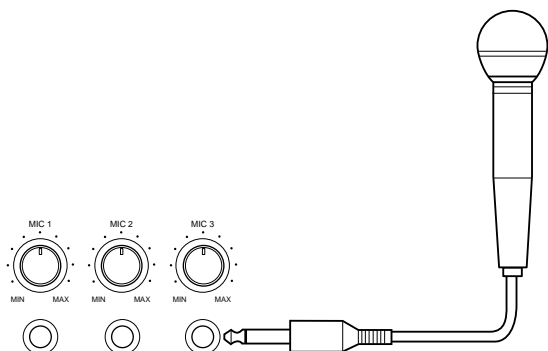

1. Turn on the microphone switch.
2. Turn the MIC 1, MIC 2, and MIC 3 knobs clockwise (level up) or counterclockwise (level down) as desired.

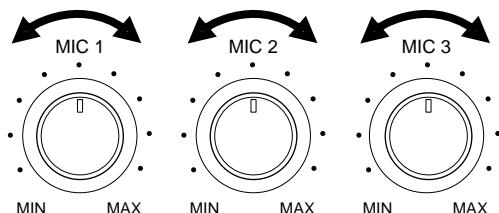

### ATTENTION

When you are not using the microphone, set the MIC switch to OFF.

### Be sure to remove the microphone

Note when connecting the sound output to the input of a TV or VCR: If an excessively strong signal is given to a unit through a microphone, for example when using Karaoke, it may cause an adverse effect such as distorted sound. Lower the sound volume using the microphone control.

### Karaoke etiquette

Think of your neighbors when you are enjoying karaoke music. Particularly late at night, the sound you enjoy may reach your neighbors more than you expect. Common sense and courtesy are always appreciated.

## Adjusting music key

Press the KEY CONTROL buttons ( ♭ or # ) to change the key in which the music plays. To return the music to its original key, press the NORMAL button.

You can also adjust the music using the remote control unit.

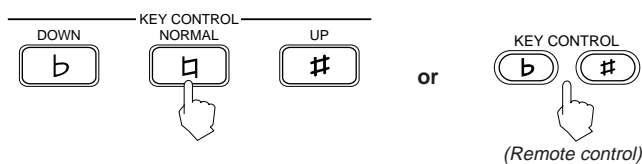

### Notes

- The degree the key has been raised or lowered is displayed on the television screen.
- When the song ends, the key control will return to NORMAL mode automatically.

## Adjusting echo effect

You can add echo to your voice.

Turn the DIGITAL ECHO knob clockwise (level up) or counterclockwise (level down) to adjust the echo effect as desired.

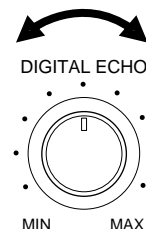

### Vocal replace

---

#### Preparation

This function is used for multiplex sound discs.

#### Operation

1. Press the V.REPLACE button during play or stop. REPLACE will appear on the display window and VO.REPLACE will appear on the television screen. When you start singing, the disc vocal is removed and your voice is inserted into the music.

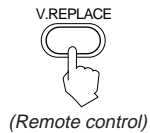

2. To cancel voice replacement, press the V.REPLACE button again.

#### Note

- You cannot use the Vocal replace function with a disc that has vocals recorded on the left channel.

### Vocal effect

---

By pressing the VOCAL EFFECT button, you can apply a vocal effect to the microphone input signals. Three effect modes are available; HARMONY, CHORUS and FLANGE. The selected mode is shown on the television screen, while the VOCAL EFFECT button on the player lights when any of the effect modes is selected.

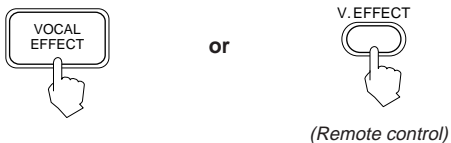

# OPERATION OF PLAYBACK CONTROL FUNCTION

## Playing Video CDs and SVCDs with Playback Control function

This player provides a Playback Control function which utilizes a procedure (menu selection) programmed in a Video CD or SVCD. The playback operation procedure may differ depending on the disc you use.

The Playback Control function provides:

- High-resolution still image display - Super-fine reproduction of still images with more than four times the resolution of video tape.
- Menu-driven playback - interactive menus for easy selection of tracks.

### Preparations

- A Video CD or SVCD with the Playback Control function is required for this operation.
- The PLAY MODE switch must be set to NORMAL.
- The buttons used for operating the PBC function are the number keys, the  $\leftarrow$  /  $\rightarrow$  PREV/NEXT buttons,  $\blacktriangleright$  (PLAY)/SELECT button, and  $\circ$  RETURN button.

### Button functions

Number keys ..... Select a specific menu item from the television screen or monitor.

$\leftarrow$  /  $\rightarrow$  PREV/NEXT buttons .... Move through menu etc.

$\blacktriangleright$  (PLAY)/SELECT button ..... When " $\blacktriangleright$ " or "SELECT" is displayed on the television screen, pressing this button jumps to the specific picture.

$\circ$  RETURN button ..... Returns to the menu.

$\blacksquare$  (STOP) button ..... Stops operations.

### Operation

1. Verify that the PLAY MODE switch is set to NORMAL.
2. Press the CD (1 through 3) or  $\blacktriangleright$  (PLAY)/SELECT button. The player starts up the PBC function. "Pb" is shown in the display window. The main menu is displayed on the television screen.

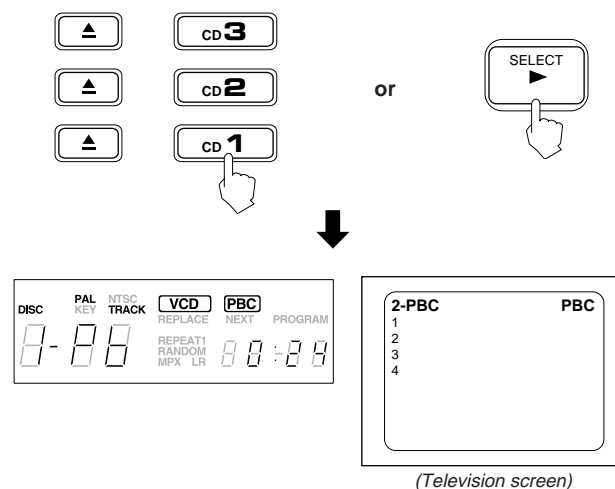

3. To move through the disc menus, press the  $\leftarrow$  /  $\rightarrow$  PREV/NEXT button.

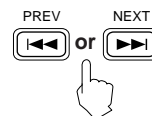

4. When the disc menu you want appears, select an item in the menu by using the number keys. The numbers on the number keys correspond to the menu item numbers.
5. To return to a menu press, the  $\circ$  RETURN button.



### Notes

- Page numbers in the disc menu show that preceding pages exist. To move from the current menu, press the  $\leftarrow$  /  $\rightarrow$  PREV/NEXT button.
- If you have no desire to use the PBC function when playing a disc with the PBC function, switch the PLAY MODE switch to "PBC OFF" before playing.
- If you switch the mode from NORMAL to PBC OFF while playing back a PBC disc, playback will stop. Operate the procedure above again from the beginning.
- If you press the number keys directly to select the track before playing, you cannot enter PBC mode regardless of the PLAY MODE switch setting.

**Video CDs and SVCDs with Playback Control function**

**What is Playback Control function?**

The Playback Control function, allows you to enjoy menu-driven operation and high-resolution still images which have a resolution four times greater than moving pictures.

- **Menu-driven playback**  
You can interact with the screen using a menu display to select and play an entry.
- **High-resolution still image display**  
You can display high-quality images four times clearer than moving pictures.

**Example of playback using the Playback Control function**

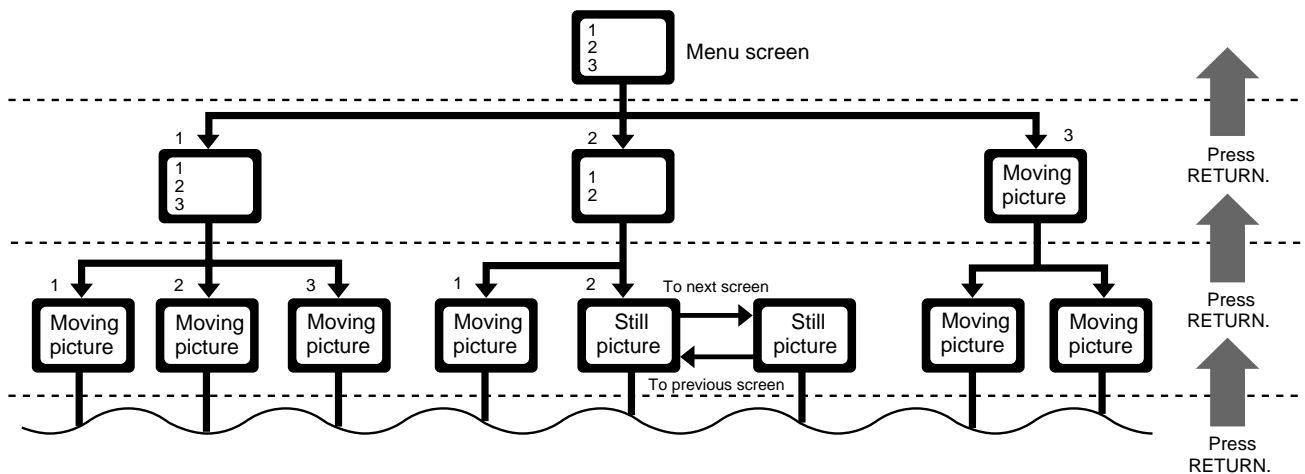

A selection menu is displayed when you start playing a Video CD and SVCD disc with the Playback Control feature. The selection menu shows a list of numbers for selection. Some discs may show moving pictures or a divided screen.

1. When a list of numbers is displayed, selecting a number shows its contents.
2. When "▶" or "SELECT" is displayed on the television screen, pressing this button jumps to the specific picture.

3. When the selection menu is redisplayed after you have played your selection, selecting a number again replays its contents. (Some discs may show the menu screen several times.) When (▶▶) and (◀◀) are shown, pressing "NEXT" or "PREV" can change the selection menu.
4. After playback, press ⏪ RETURN to go back to the previous screen. To stop playback, press ■ (STOP).

**Note**

- When a menu is displayed for a long time (about ten minutes), the screen background automatically fades out to prevent screen burn-in while the setting is suspended.



# RESTRICTING USE OF YOUR DISCS

## Locking a disc with the Read-Protect function

### Locking a disc

The Read-Protect function restricts viewing of a disc. Only people who know the code can unlock the disc. You can lock only Video CDs and SVCDs (up to ten discs).

#### Notes

- You cannot lock a disc while it is playing.
- All Read-Protect operations are performed using buttons on the player, not on the remote control.

#### Operation

1. Play the disc for a moment, then press the ■ (STOP) button.

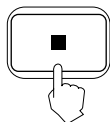

2. Hold down the NEXT button on the player for at least three seconds. The track and time numbers are no longer displayed.



3. Press the number key "8" four times. The display window indicates "Loc."

Now the disc cannot be viewed. You can open and close the tray and you can turn the player power on and off, but no other functions are available for this locked disc.

#### Note

- PROTECT is displayed on the television screen.

Cut out the following instructions and keep them separately, to ensure privacy.

### Canceling Read-Protect

#### Operation

1. Place the disc in a tray, then press the CD button (1 - 3) for that tray. PROTECT is displayed on the television screen.

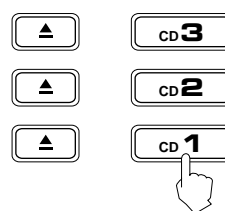

2. Hold down the ◀◀ PREV (Previous) button on the player for more than three seconds. The indication "Loc" in the display window will flicker for a moment.



3. Press the number key "8" four times. You can now play the disc.

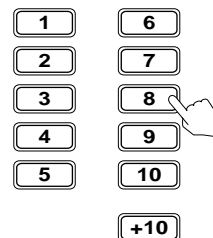

### Releasing the Read-Protect temporarily

#### Operation

1. As above, hold down the ◀◀ PREV (Previous) button on the player for at least three seconds. The indication "Loc" in the display window will flicker for a moment.

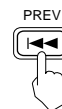

2. Press the number key "7" four times. You can now play the disc temporarily until you press the ▲ (OPEN/CLOSE) button for that disc, or until you play another disc. Turning off the player does not restore the Read Protect function.

---

# DIGITAL AUDIO CDs

## Playing Digital Audio CDs

### Playing Digital Audio CDs

---

Basically, the operations for Video CDs and SVCDs apply to the Audio CDs except for some video-related functions.

#### **Notes**

- The display has no indicator to show disc type.
- The PLAY MODE switch is ineffective for Audio CDs.

### Unavailable functions for Audio CDs

---

The following functions for Video CD and SVCD discs are not available with Audio CDs.

- Slow-motion playback
- Frame-by-frame function
- Video intro function
- Highlight function
- Bookmark function

# AV COMPU LINK REMOTE CONTROL SYSTEM

## AV COMPU LINK remote control system

When you are going to enjoy a disc, you usually have to turn on your television, receiver and Video CD player and setup these components' individually. If, however, the system consists of components which support JVC's AV COMPU LINK remote control system, instead of individual setup, simply pressing the ► (PLAY)/SELECT button allows you to enjoy the disc.

### Connection and setup

Using the AV COMPU LINK cable, connect the AV COMPU LINK terminals of each component to one another.

After the connection is done, make the player's AV COMPU LINK setting by the following procedures.

1. While the player is in the STANDBY mode, hold down the ■ (STOP) button and press the ◻ (STANDBY/ON) button. The corresponding CD button (CD1 to CD3) of the selected AV COMPU LINK setting blinks.
2. To change the selection, press the ► (PLAY)/SELECT button. Each press of the button cycles the selection as shown below.

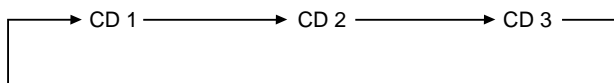

3. To exit the setting mode, press the ■ (STOP) button to return to the STANDBY mode, or press the ◻ (STANDBY/ON) button to enter the ON mode.

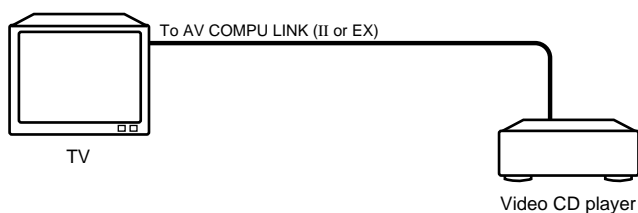

If you connect the Video CD player to a television via AV COMPU LINK as illustrated above, set the Video CD player's AV COMPU LINK setting as follows.

- When connecting with VIDEO 1 input terminal of the television: CD 2
- When connecting with VIDEO 2 input terminal of the television: CD 3

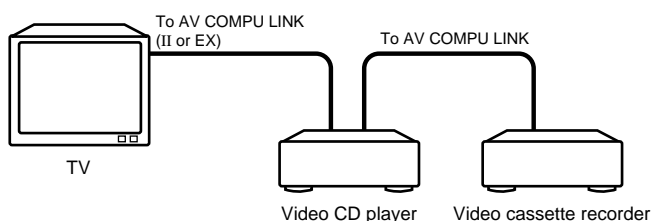

If you connect the Video CD player to a television and VCR via AV COMPU LINK as illustrated above, set the VCR's Remote Control Code and Video CD player's AV COMPU LINK setting as follows.

- When connecting with VIDEO 1 input terminal of the television:  
Video CD player's AV COMPU LINK setting: CD 2  
VCR's Remote Control Code: B
- When connecting with VIDEO 2 input terminal of the television:  
Video CD player's AV COMPU LINK setting: CD 3  
VCR's Remote Control Code: A

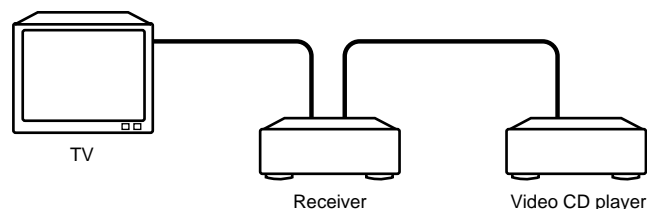

If you connect the Video CD player to a television and receiver via AV COMPU LINK as illustrated above, set the Video CD player's AV COMPU LINK setting to CD1.

### Operation

You can enjoy pictures and/or sound by just putting the Video CD player into play mode. You do not have to operate the TV and/or receiver including power switching.

#### Preparation

Set the POWER switch of each component to ON.

1. Insert a disc into the Video CD player.
2. Press ► (PLAY)/SELECT of the Video CD player.

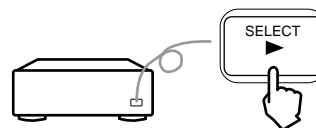

The following actions are performed automatically:

- Turning on the power of each component.
- Setting the source of the television to the external input which the Video CD player is connected to.
- Setting the source of the receiver to the Video CD player.

#### Notes for connection

- Connect the AUDIO OUT jacks of the Video CD player to the audio input jacks of a receiver which show "DVD". Otherwise, the system will not work correctly.
- There may be no description about connections to a Video CD player in the instruction manual of a television or VCR. But a television or VCR with AV COMPU LINK terminals which show II can be connected to a Video CD player.

# SPECIFICATIONS

## Main specifications

### **XL-MV777GD/XL-MV757TN**

Model	Video CD player	
Playback disc	Super VCD Video CD Digital Audio CD	
Front panel color	XL-MV777GD XL-MV757TN	Gold Titanium
Total harmonic distortion	0.01% (1 kHz)	
S/N ratio	90 dB	
Frequency response	20 Hz – 20 kHz	
Input terminal	Microphone	5 mV (5.0 kΩ)
Output terminal	Line output	2.0 Vrms (full scale)
	Video output (composite)	1.0 Vp-p (75Ω)
	S video output	
	Y: Illuminance	1.0 Vp-p (75Ω)
C: Chrominance. burst	0.286 Vp-p (75Ω)	
Echoing	Digital echoing	
Power requirements	AC 115-127/220-240 V ~ 50/60 Hz Selectable with the voltage selector	
Power consumption		16 watts
	In standby mode	6 watts
Weight	5.3 kg (11.7 lbs)	
Dimensions (W/H/D)	435 x 126.5 x 325.3 mm	
	17-3/16 x 5 x 12-13/16 inches	

### **Accessories**

AC power cord .....	1
Audio video cable .....	1
Remote control unit (RM-SXLMV777U) .....	1
Batteries (R6P(SUM-3)/AA(15F)) .....	2
AC plug adaptor (except People's Republic of China) .....	1
AV COMPU LINK cable .....	1

## Troubleshooting

What appears to be a malfunction may not always be so. Please go through the following list before requesting service.

Symptom	Possible cause	Remedy
Power does not come on.	Power plug is disconnected from AC outlet.	Firmly connect the plug to AC outlet.
	The POWER button is in the OFF position.	Depress the POWER button.
Remote control does not work.	Batteries are exhausted.	Replace the batteries with new ones.
	The tip of the remote control unit is not pointed at the receiving part of the player.	Use the remote control correctly.
No image is displayed on the monitor.	The video cable is not connected.	Firmly connect the cable.
	The TV is not set in video mode.	Set the TV in video mode.
	An incompatible disc is loaded.	Load a disc compatible with the player.
Playback does not start.	No disc is loaded.	Load a disc.
	Disc is loaded upside down.	Reload the disc with the label up.
Speaker does not produce sound.	Audio cable is not connected.	Firmly connect the cable.
	Operation of the external amplifier is incorrect.	Operate the amplifier correctly.
Sound is distorted or noise is generated. Image is garbled.	Disc is dirty.	Wipe the disc surface with a soft cloth.
	Connection is wrong.	Correctly connect cables. See page 2.
Sound is intermittent. Image is garbled.	Disk is dirty.	Wipe the disc surface with a soft cloth. See page 1.
	Disc is scratched.	Replace the disc with a new one.
	Disc is warped.	
Disc tray does not come out when ▲ (OPEN/CLOSE) button is pressed.	Power plug is disconnected from the power outlet.	Firmly insert the plug into the outlet.
Operation is not possible.	Microcomputer malfunctions due to lightning or static electricity.	Turn the power off, then on again.
The AV COMPU LINK system does not work correctly.	The player's AV COMPU LINK setting is not correct.	Make the setting correctly.

The malfunction may be caused by a device other than the player. Check other devices connected to the player.

## AC Power Line Instructions (not applicable for Europe, U.S.A., Canada, Australia and U.K.)

主(AC)电源线路说明 (不适用于欧洲、美国、加拿大、澳洲及英国型号)

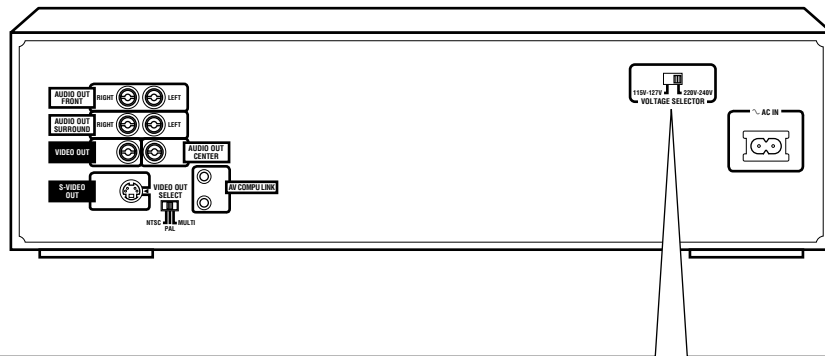

### IMPORTANT

BEFORE PLUGGING IN, check that your AC power line voltage corresponds with the position of the voltage selector switch provided on the outside of this equipment. If different, reset the voltage selector switch, to prevent damage or risk of fire/electric shock.

### 有关主(AC)电源线路的重要事项

接插电源以前, 务请检查当地的主(AC)电源线路电压是否和位于本机外面的电压选择开关设定的位置一致。如果不一致, 即重新设定电压选择开关使符合当地电压, 以免损坏机器或引起火灾/触电的危险。